

1980 — 2020

40 YEARS OF

Groundbreaking solutions



Groundbreaking solutions. From physicians for physicians.

Though much has changed at Boston Medical Products over the past 40 years, one thing remains constant: our commitment to deliver the world's finest specialty surgical products — products that ENT physicians can rely on and patients can trust.



Boston Medical Products was founded in 1980 by three physicians - including world-renowned surgeon **William W. Montgomery, M.D.** as a way to make Dr. Montgomery's original innovations widely available to fellow physicians.

Today, Boston Medical Products continues to be driven by his life-long commitment to superior patient care.

William W. Montgomery, M.D. 1923-2003



Office, production and warehouse in Shrewsbury, Massachusetts

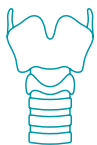

Boston Medical Products is the only manufacturer in the world authorized to produce Montgomery® brand products.

Simplicity, ease of use by physicians, and patient comfort have been the hallmarks of our innovations from the Montgomery® Safe-T-Tube, originally patented in 1973, to the Montgomery® Thyroplasty System.

The original Montgomery® brand



Unmatched Physician and Patient Support

We support our customers through our highly trained Customer Service Team, who are ready to answer technical questions, assist with ordering, and ensure timely delivery.



a bess group company

Since 2007 Boston Medical Products, Inc. has been part of bess group in Berlin, Germany – a family-owned and managed medical device company with more than 30 years of expertise in medical device technology.

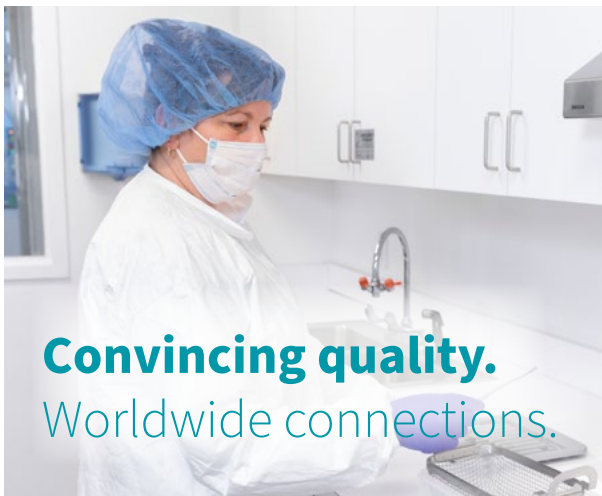

Convincing quality.
Worldwide connections.

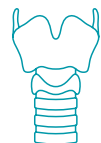
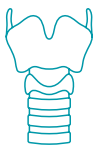

Table of contents

Montgomery® Safe-T-Tubes™	p. 6-13
Pediatric — 3200 Series	p. 10
Standard — 4200 Series.....	p. 10
Thoracic — 5200 Series	p. 10
Extra-Long — 6200 Series.....	p. 11
Tapered — 7200 Series	p. 11
Laryngeal Products	p. 14
Montgomery® Laryngeal Stent	p. 15
Rutter Supra-Stomal Stent.....	p. 16
Montgomery® Laryngeal Keel.....	p. 17
Esophageal Tubes.....	p. 18
Montgomery® Salivary Bypass Tube.....	p. 19
Har-El Pharyngeal Tube	p. 20
Montgomery® Esophageal Tube	p. 21
Montgomery® Tracheal Cannula System	p. 22
Montgomery® Initial Cannula Set	p. 24
Montgomery® Short-Term Cannula	p. 25
Montgomery® STOMEASURE™	P. 26
Montgomery® Long-Term Cannula	p. 27
Moore Tracheostomy Tube	p. 28
Singer Laryngectomy Tube	p. 29
Montgomery® Tracheostomy Speaking Valve	p. 30
Montgomery® Cannula Speaking Valves	p. 31



Montgomery® Thyroplasty Implant Systemp. 32

The Designp. 34

System Optionsp. 36

Products for Otolaryngology and Rhinologyp. 39

OTOSILK™ Otolaryngological Strips.....p. 40

OTOSILK™ Graft Dressingp. 40

Doyle Ear Dressing.....p. 41

Doyle Open-Lumen Splint.....p. 42

Nasal Airway Splintp. 42

Intranasal Splint INSp. 43

Bivalve Nasal Splint.....p. 43

Custom Nasal Splintp. 43

Nasal Septal Button.....p. 44

Salman FES Stentp. 44

Epi-Max™ Epistaxis Catheterp. 45





The Montgomery[®] Safe-T-Tube[™]

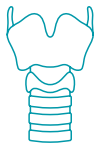



Intended Use

To maintain an adequate tracheal airway, as well as to provide support in the stenotic trachea that has been reconstituted or reconstructed.

Indications

- Acute laryngotracheal injuries
- Intrathoracic tracheal stenosis
- Reconstructed trachea
- Reconstituted trachea
- Tracheal stenosis when the cervical or thoracic trachea cannot be repaired
- Segmental resection and anastomosis
- Cervical trachea that cannot be repaired

Five styles available

Pediatric Safe-T-Tube™ (3200 Series)

Standard Safe-T-Tube™ (4200 Series)

Thoracic Safe-T-Tube™ (5200 Series)

Extra-Long Safe-T-Tube™ (6200 Series)

Tapered Safe-T-Tube™ (7200 Series)



Montgomery®

Safe-T-Tube™

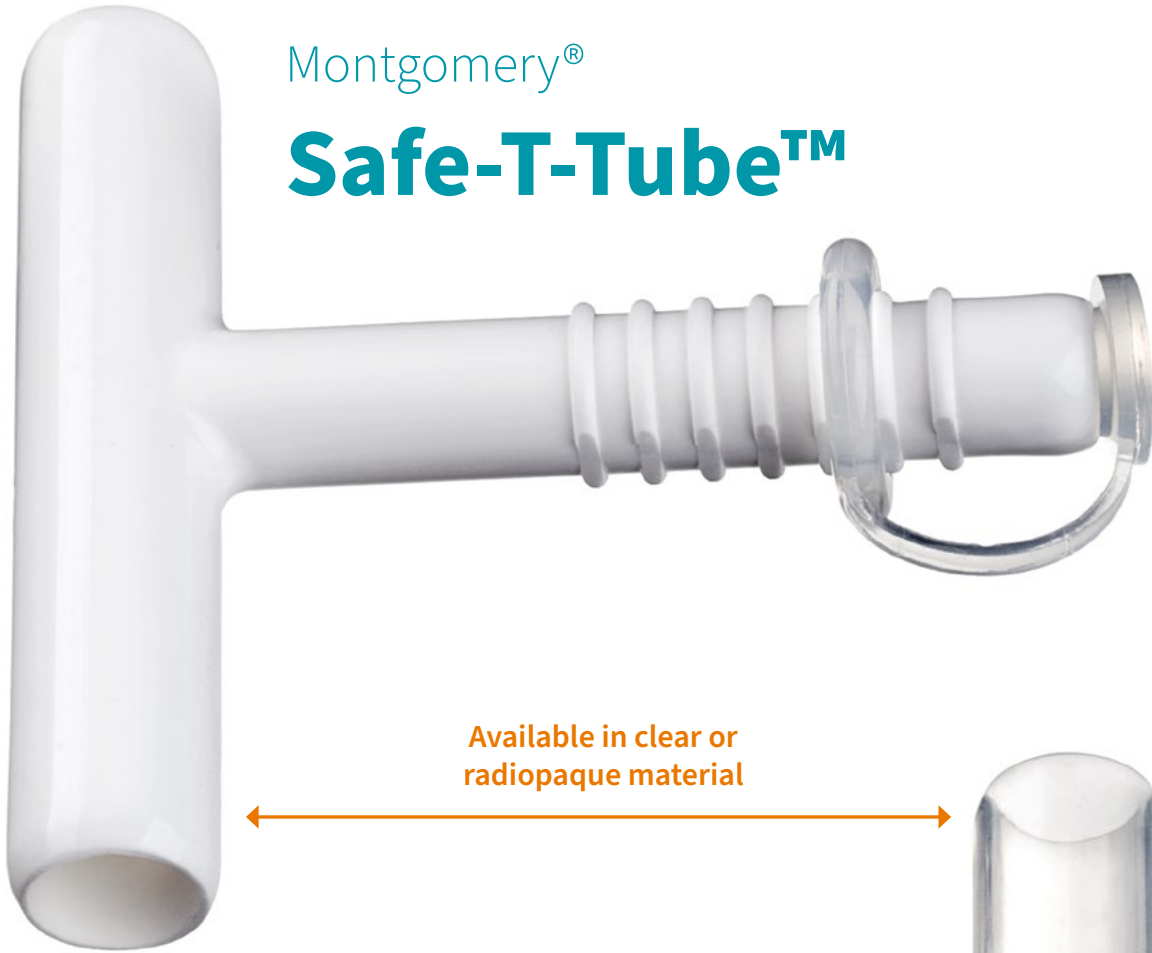

Available in clear or
radiopaque material

Special situations require
shortened Safe-T-Tube™ limbs.

We offer a service to shorten
any Safe-T-Tube™ to your
exact dimensions and
finish the ends
with a smooth taper.

Please call Customer Service
+1 (508) 898-9300

Implant-grade silicone,
non-adherent smooth
surface

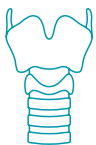

Original Features



Montgomery®
Cannula Speaking Valves

Ridges and grooves

along the extraluminal limb of the tube allow a ring washer to be attached, significantly reducing the possibility of accidental posterior displacement.



Video available



Speaking valves facilitate vocalization



Safe-T-Tubes™ are easy to insert, suction and remove, and can be used with anesthesia.

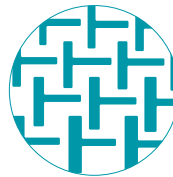

Safe-T-Tubes™ come in a large variety of sizes.

Each Safe-T-Tube™ is supplied sterile.

Carton contains 1 Tube,
2 Plug/Ring Sets, 1 Patient-PAK™.

2 Plug/Ring Sets are included with each Safe-T-Tube.

Extra Plug/Ring Sets are available separately.



Montgomery®

Safe-T-Tube™

Available in five styles



Standard

The **4200 Series Standard Safe-T-Tube™** is the original design featuring dimensions that will work for the majority of surgical cases.



Pediatric

The **3200 Series Pediatric Safe-T-Tubes™** feature an angled extraluminal limb to facilitate suctioning and airway management.



Thoracic

The **5200 Series Thoracic Safe-T-Tube™** features an extra-long lower limb for thoracic applications.

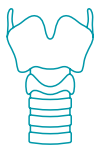



Extra-Long

The **6200 Series Extra-Long Safe-T-Tube™** is designed to provide the surgeon the total freedom to customize the intraluminal limbs to any desired length.

Tapered

The **7200 Series Tapered Safe-T-Tube™** is designed to assist with the management of tracheal, subglottic, and glottic stenoses. The superior end conforms to the contour of the glottis and subglottis, while the larger inferior portion simultaneously acts as a stent for the trachea. The tapered end is designed to project up beyond the true vocal cords to the level of the laryngeal ventricle.

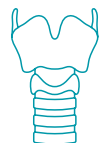

Montgomery®

Safe-T-Tube™

Ordering information

Pediatric

3200 Series Pediatric Safe-T-Tubes™

Size	REF		Dimensions (mm)						REF
	Clear	Radiopaque	A	B	C	D	E	F	Plug/Ring Set
6	320006	32006R	6	94	46	42	45	6	321066
7	320007	32007R	7	95	46	43	45	6	321066
8	320008	32008R	8	96	46	42	45	8	321086
9	320009	32009R	9	97	46	43	45	8	321086

Supplied sterile. Carton contains 1 Tube, 2 Plug/Ring Sets.
Accessories purchased separately (321xxx) are supplied non-sterile.

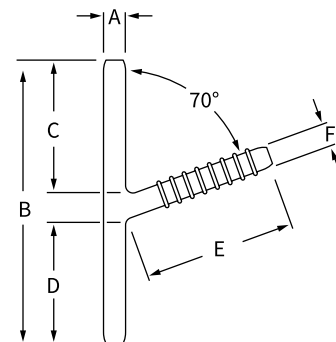

Standard

4200 Series Standard Safe-T-Tube™

Size	REF		Dimensions (mm)						REF	
	Clear	Radiopaque	A	B	C	D	E	F	Plug/Ring Set	15 mm Adaptor
10	420010	42010R	10	50	19	23	39	8	321106	321107
11	420011	42011R	11	60	20	29	52	11	321126	321127
12	420012	42012R	12	65	23	32	50	11	321126	321127
13	420013	42013R	13	69	24	34	55	11	321126	321127
14	420014	42014R	14	71	25	35	59	11	321126	321127
15	420015	42015R	15	73	26	36	56	11	321126	321127
16	420016	42016R	16	75	27	37	65	11	321126	321127

Supplied sterile. Carton contains 1 Tube, 2 Plug/Ring Sets.
Accessories purchased separately (321xxx) are supplied non-sterile.

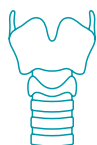
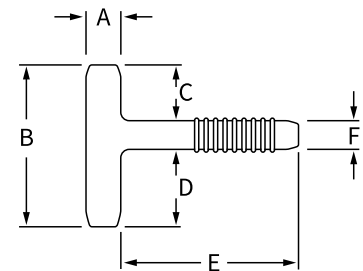

Thoracic

5200 Series Thoracic Safe-T-Tube™

Size	REF		Dimensions (mm)						REF	
	Clear	Radiopaque	A	B	C	D	E	F	Plug/Ring Set	15 mm Adaptor
10	520010	52010R	10	113	31	74	38	8	321106	321107
11	520011	52011R	11	115	30	74	50	11	321126	321127
12	520012	52012R	12	112	29	72	50	11	321126	321127
13	520013	52013R	13	116	31	74	55	11	321126	321127
14	520014	52014R	14	118	32	75	58	11	321126	321127
15	520015	52015R	15	119	33	75	56	11	321126	321127
16	520016	52016R	16	119	33	75	65	11	321126	321127

Supplied sterile. Carton contains 1 Tube, 2 Plug/Ring Sets.
Accessories purchased separately (321xxx) are supplied non-sterile.

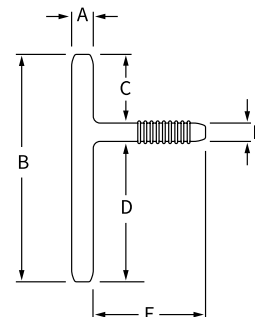

Extra-Long

6200 Series Extra-Long Safe-T-Tube™

Size	REF		Dimensions (mm)						REF	
	Clear	Radiopaque	A	B	C	D	E	F	Plug/Ring Set	15 mm Adaptor
10	620010	62010R	10	161	76	76	39	8	321106	321107
11	620011	62011R	11	162	76	76	52	11	321126	321127
12	620012	62012R	12	162	76	76	48	11	321126	321127
13	620013	62013R	13	163	76	76	57	11	321126	321127
14	620014	62014R	14	163	76	76	59	11	321126	321127
15	620015	62015R	15	163	76	76	58	11	321126	321127
16	620016	62016R	16	163	76	76	65	11	321126	321127

Supplied sterile. Carton contains 1 Tube, 2 Plug/Ring Sets.
Accessories purchased separately (321xxx) are supplied non-sterile.

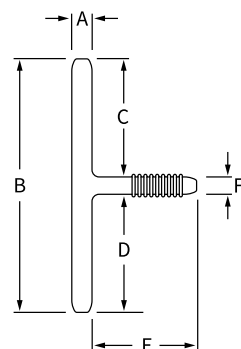

Tapered

7200 Series Tapered Safe-T-Tube™

Size	REF		Dimensions (mm)							REF	
	Clear	Radiopaque	A	B	C	D	E	F	G	Plug/Ring Set	15 mm Adaptor
8/10	721008	71008R	8	163	77	78	69	8	10	321106	321107
10/13	721310	71310R	10	163	76	76	72	11	13	321126	321127

Supplied sterile. Carton contains 1 Tube, 2 Plug/Ring Sets.
Accessories purchased separately (321xxx) are supplied non-sterile.

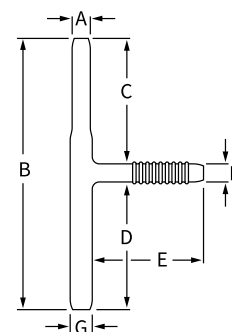

Montgomery®

Laryngeal Products

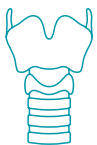

Montgomery®

Laryngeal Stent

For the prevention and treatment of laryngeal stenosis when the glottic stenosis involves the midglottis, posterior glottis, supraglottis, and subglottis, singularly or in combination.

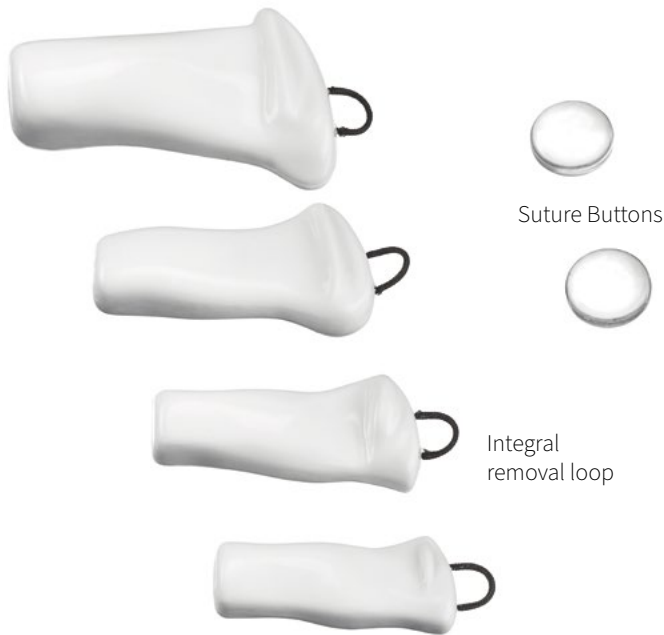

- Designed to conform to the normal endolaryngeal surface.
- Firm enough to support the endolarynx post operatively, yet soft and flexible enough to ensure a conforming fit while minimizing injury to soft tissues.
- May be utilized as a direct support for intralaryngeal mucosal or dermal grafts to denuded areas of the endolarynx.
- Made of radiopaque implant-grade silicone with a non-adherent smooth surface and an integral removal loop

Size	REF	Dimensions (mm)		
		A	B	C
Child	323010	33	10	9
Small Adult	323020	37	11	10
Medium Adult	323025	40	12	10
Large Adult	323030	47	15	16

Supplied sterile, with 2 Suture Buttons per carton. Additional Suture Button pairs are available, non-sterile (REF: 323011).

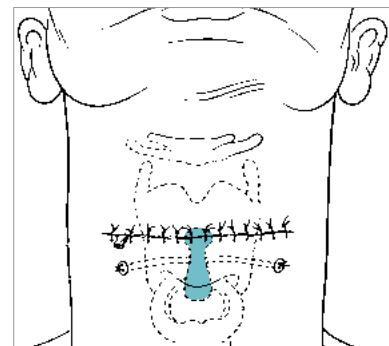
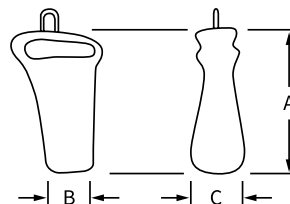

Rutter Supra-Stomal Stent

Stent system made of radiopaque implant-grade silicone with a non-adherent smooth surface to aid in the prevention and treatment of laryngeal and tracheal stenosis.

Video available



Main body of the stent features two tapered ends. The end with the smaller inner diameter is designed to lie distally at the tracheostoma and may even slightly overlap the tracheostoma. The proximal end of the stent accommodates one of the supplied plugs and can be trimmed for custom stent length.

10 sizes available



Fenestrated plug for limited airflow through the stent and vocalization in some patients

Non-fenestrated plug for use in patients with a high risk of aspiration

REF	Size	Dimensions (mm)	
		A	B
840006	6	6	83
840007	7	7	83
840008	8	8	88
840009	9	9	93
840010	10	10	93
840011	11	11	100
840012	12	12	126
840013	13	13	133
840014	14	14	140
840015	15	15	147

Supplied sterile. One Stent per carton.

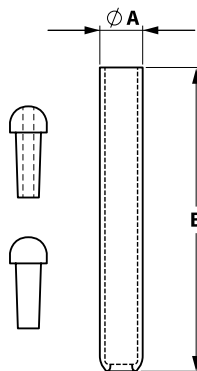

Montgomery®

Laryngeal Keel

- Soft implant-grade silicone
- Non-adherent smooth surface
- Available in 3 sizes in clear or radiopaque material



Unique umbrella shape

The intralaryngeal extension of the keel is thinner than the umbrella of the extralaryngeal portion.

Video available



For the repair of anterior subglottic stenosis (web), with or without vocal cord paralysis

Use of the Keel can be made following repair of stenosis or following removal of the Montgomery® Laryngeal Stent to aid in formation of a sharp anterior commissure.

The Keel can also be beneficial to prevent stenosis following a hemilaryngectomy.

The extralaryngeal portion, when secured to thyroid laminae with a figure-of-eight suture, covers the thyrotomy repair with its umbrella.

Tightly secured, the keel prevents stenosis and the migration of granulation tissue into the larynx.

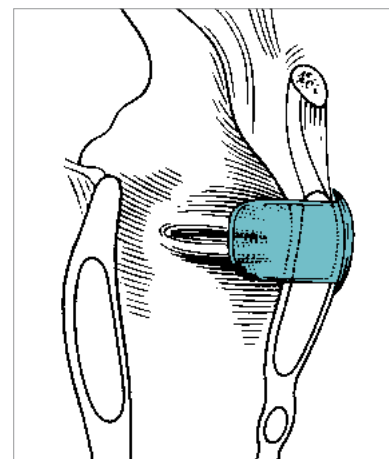
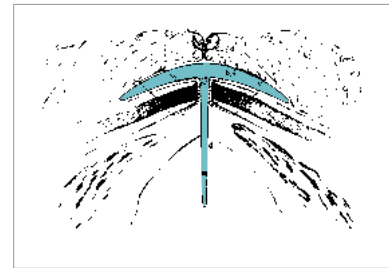

Size	REF		Dimensions (mm)
	Clear	Radiopaque	A
12	323040	323040R	12
14	323050	323050R	14
16	323060	323060R	16

Supplied sterile. One Keel per carton.

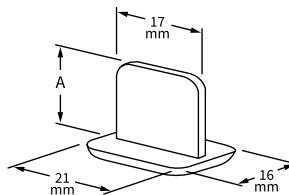

Montgomery®

Esophageal Tubes

- Implant-grade silicone
- Non-adherent smooth surface
- Available in clear or radiopaque material

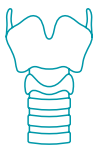

Montgomery®

Salivary Bypass Tube

To stent repair of cervical esophageal and hypopharyngeal strictures, to prevent fistulae or facilitate the management of fistulae resulting from a variety of causes including surgery, radiation, advanced malignancy, trauma, and ingestion of caustic agents.

The constant bathing by saliva around the tissues altered by surgery, infection, or radiation therapy is a prime factor in hindering the progress of healing and fistula closure.

The Montgomery® Salivary Bypass Tube directs the saliva into the distal esophagus and allows for spontaneous closure of the fistula, or at least permits the tissue to recover sufficiently to be an improved recipient for more formidable measures such as repair using pedicled skin flap tissue.

A feeding tube may be inserted through the salivary bypass tube. Impending fistulae and strictures may be prevented by tube placement alone or following bougienage dilation.

7
sizes
available



Size	REF		Dimensions (mm)		
	Clear	Radiopaque	A	B	C
8	322080	322080R	33	191	8
10	322100	322100R	35	191	10
12	322120	322120R	37	191	12
14	322140	322140R	39	191	14
16	322160	322160R	41	191	16
18	322180	322180R	43	191	18
20	322200	322200R	45	191	20

Supplied sterile. One Tube per carton.

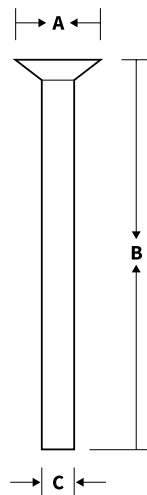

Har-El Pharyngeal Tube

To facilitate the management of esophageal fistulae resulting from a variety of causes including surgery, radiation, advanced malignancy, trauma, and ingestion of caustic agents.



- for the treatment of orocutaneous and pharyngocutaneous fistulae following head and neck oncologic resection
- placement in patients with an existing fistula prior to reconstructive procedures
- prophylactic placement in patients who are at high risk for development of a fistula.

The proximal end features an indented funnel shape designed for anchoring the device at the level of the tongue base.

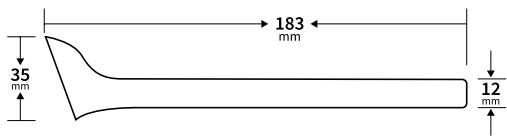

REF	
Clear	Radiopaque
355120	355120R
Supplied sterile. One Tube per carton.	

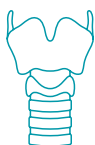
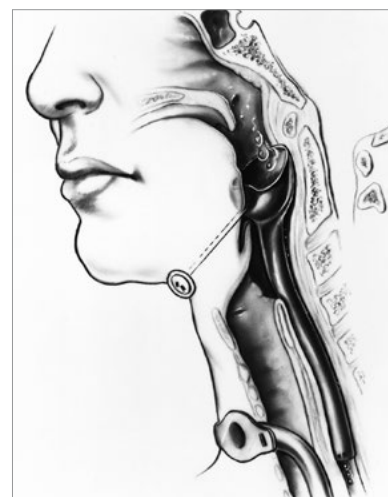

Montgomery®

Esophageal Tube

For two-stage reconstruction of the cervical esophagus

- temporarily bridges the gap between the pharyngostome and esophagostome following laryngoesophagectomy and first-stage reconstruction of the cervical esophagus
- maintains a widely patent pharyngostome and esophagostome
- tends to eliminate the problem of profuse salivary leakage by way of the pharyngostome
- creates a trough between the pharyngostome and esophagostome, facilitating the second-stage procedure

Funnel-shaped proximal end to conform to the hypopharynx.

Two firm oval bands designed to ensure proper positioning and to prevent leakage of saliva after laryngoesophagectomy.

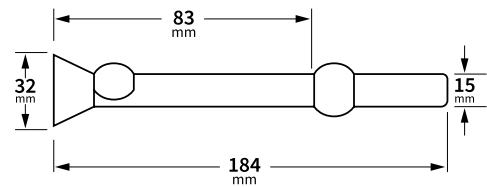
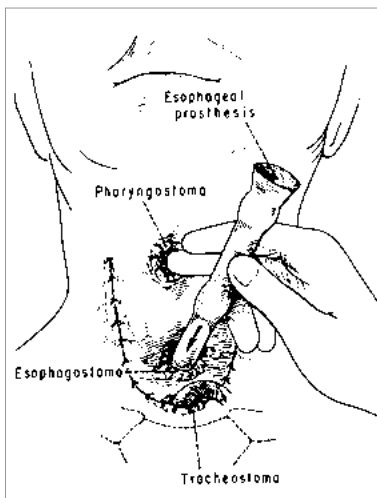

REF	
Clear	Radiopaque
322000	322000R
Supplied sterile. One Tube per carton.	

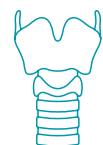

Montgomery®

Tracheal Cannula System

consisting of

- Initial Cannula Set
- Short-Term Cannula (incl. Faceplate)
- STOMEASURE™
- Long-Term Cannula
- Plug/Ring
- Speaking Valves
- 15 mm Adaptor



Long-Term Cannula

Video available



15 mm Adaptor

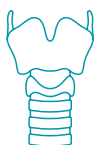



Plug/Ring



Fenestrator

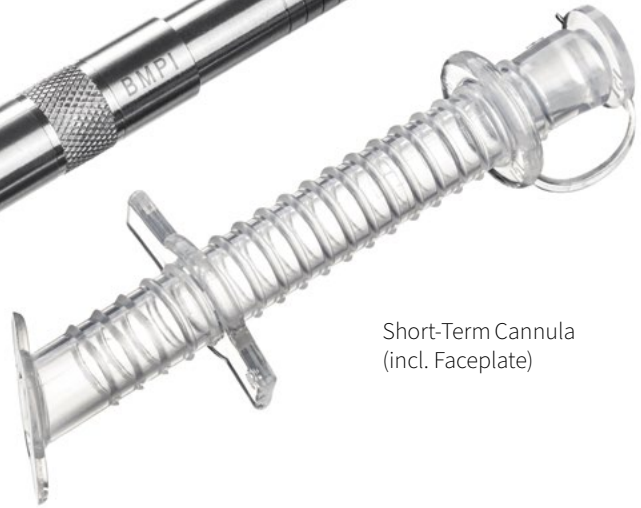

Short-Term Cannula
(incl. Faceplate)



Speaking Valves



STOMEASURE™

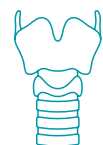

Montgomery®

Initial Cannula Set

The Montgomery® Initial Cannula Set includes one Short-Term Cannula and the corresponding Tracheal Fenestrator — everything needed to create a precise secondary airway.

Serrated blade to penetrate both the tissue and cartilage.



The fenestrator's inner cannula, connected to standard suction tubing, adheres the instrument to the desired location on the anterior tracheal wall while the knife is rotated to make the incision. The use of suction in this manner also prevents the patient from aspirating the incised tracheal core.

SIZE	REF
4	330400
6	330600
8	330800
10	331000

Supplied sterile.
One Cannula,
one Faceplate,
one Plug/Ring set,
one Fenestrator
per carton.

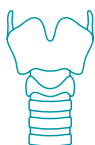

Montgomery®

Short-Term Cannula

To provide a secondary airway in place of a standard tracheostomy tube and to retain the stoma opening after creation of a new tracheotomy.

Can be left in place for several weeks and should then be replaced by the Montgomery® Long-Term Cannula to establish a long-term stoma.



- No tube projecting into the trachea
- Flexible medical grade silicone
- Extra-long length that can be trimmed following insertion
- Angled internal flange ensures proper positioning and rests on the anterior tracheal wall.
- Three barbed rings adjacent to the cannula flange reside in the tracheostoma and help secure the cannula while the tracheotomy heals
- Faceplate is sutured to the skin for additional immobilization of the cannula.

SIZE	REF	Dimensions (mm)		REF		
		A	B	Plug/Ring Set	15 mm Adaptor	Faceplate
4	330401	9	101	310406	310404	310403
6	330601	11	101	310606	310604	310603
8	330801	12	101	310806	310804	310803
10	331001	13	101	311006	311004	311003

Supplied sterile. One Cannula, one Faceplate, one Plug/Ring set per carton.
Accessories available separately (31xxxx) are supplied non-sterile.

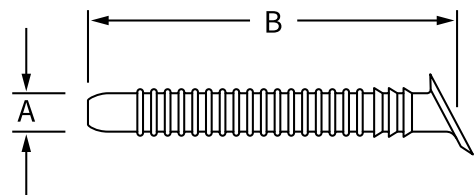

Montgomery®

STOMEASURE™

To accurately measure the tracheal stoma for proper fitting of the Montgomery® Long-Term Cannula.

- Measures both the diameter and length of the stoma. With these measurements, the physician can select a Long-Term Cannula model to fit most tracheotomies.
- The stoma length in centimeters is measured along the inferior aspect of the stoma from the anterior tracheal wall to the outside skin.

REF	
STM100	STOMEASURE™
Supplied sterile. One item per carton.	



Measuring Stoma Length

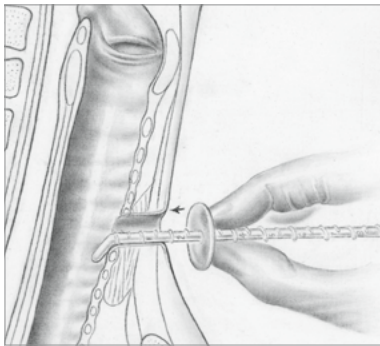

Measuring Stoma Diameter

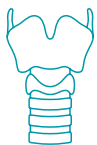
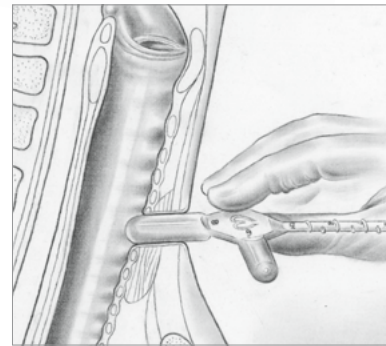

Montgomery®

Long-Term Cannula

Used to replace either the Short-Term Cannula or a standard tracheostomy tube to establish a long-term tracheostoma.

- Can be trimmed
- Ring washer for safety

27°-angled flange to ensure that the tube rests horizontally when seated in the trachea - nothing protrudes into the trachea.

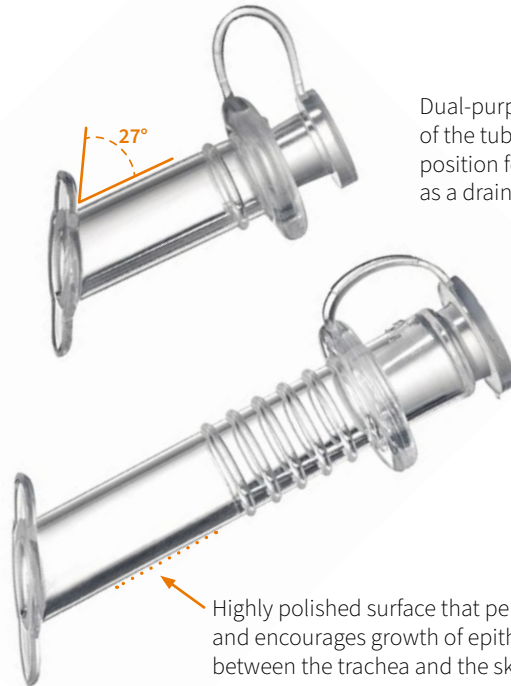

Dual-purpose groove along the axis of the tube rests in the “6 o’clock” position for orientation and serves as a drainage vent.

Highly polished surface that permits and encourages growth of epithelium between the trachea and the skin.

24 sizes available

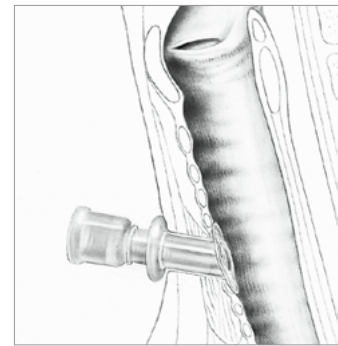
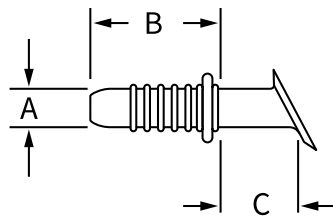

SIZE	Dimensions (mm)		REF for the following stoma lengths (dimension “C”) in millimeters						REF	
	A	B	17-25	25-33	33-41	41-49	49-57	57-65	Plug/Ring Set	15 mm Adaptor
4	9	37	330425	330433	330441	330449	330457	330465	310406	310404
6	11	37	330625	330633	330641	330649	330657	330665	310606	310604
8	12	37	330825	330833	330841	330849	330857	330865	310806	310804
10	13	37	331025	331033	331041	331049	331057	331065	311006	311004

Sterile, for single patient use. 1 Cannula, 2 Plug/Ring Sets, 1 Patient-Pak per carton.
Accessories available separately (31xxxx) are supplied non-sterile.



Moore Tracheostomy Tube

To maintain an adequate airway while providing support in the stenotic cervical or thoracic trachea.

- Four components: Silicone tracheostomy tube with obturator and two inner cannulas
- Flexible to conform to individual anatomies while providing patient comfort
- Made of radiopaque silicone to aid in reducing incrustation and clotting
- Standard long length can be trimmed for individual applications
- Extra inner cannulas available as replacement

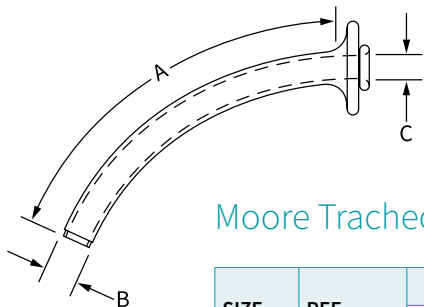

Moore Tracheostomy Tube

SIZE	REF	Dimensions (mm)		
		A	B	C
6	MTT-006	109	11	6.5
8	MTT-008	109	12	7.5
10	MTT-010	109	13	8.5

Supplied sterile. Includes outer tube, obturator, low-profile inner cannula and inner cannula with 15 mm connector.

Replacement Inner Cannulas

SIZE	REF	Description
6	MTT-006-CN	15 mm Inner Cannula
	MTT-006-LP	Low-Profile Inner Cannula
8	MTT-008-CN	15 mm Inner Cannula
	MTT-008-LP	Low-Profile Inner Cannula
10	MTT-010-CN	15 mm Inner Cannula
	MTT-010-LP	Low-Profile Inner Cannula

Supplied sterile. 2 Cannulas per carton (1 cannula per pouch, 2 pouches per carton).

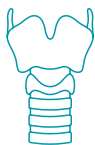

28 sizes available



Flange slots accommodate a neck strap or trach tape. Covering a wider surface area, the flange design helps keep trach tape and holders away from the healing tracheostoma.

Singer Laryngectomy Tube

Flexible silicone tracheostomy tube designed to maintain the tracheostoma following laryngectomy surgery.

Can also be used to prevent tracheostoma stenosis for the laryngectomy patient on a longer-term basis.

SIZE	Diameter (mm)		Length (mm)			
	O.D.	I.D.	18	27	36	55
8	12.0	9.5	SLT-0818	SLT-0827	SLT-0836	SLT-0855
9	13.5	10.5	SLT-0918	SLT-0927	SLT-0936	SLT-0955
10	15.0	12.0	SLT-1018	SLT-1027	SLT-1036	SLT-1055
11	16.0	13.0	SLT-1118	SLT-1127	SLT-1136	SLT-1155
12	17.0	13.5	SLT-1218	SLT-1227	SLT-1236	SLT-1255
14	20.0	16.5	SLT-1418	SLT-1427	SLT-1436	SLT-1455
16	24.0	20.5	SLT-1618	SLT-1627	SLT-1636	SLT-1655

Supplied sterile. One Cannula per carton.

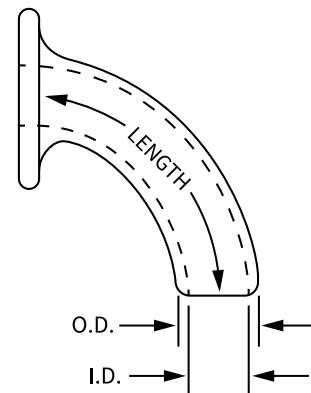



Montgomery®

Tracheostomy Speaking Valve

Designed to allow tracheostomy patients to vocalize without the need for finger occlusion.

The valve provides one-way airflow using a thin silicone diaphragm that opens on inspiration and closes on expiration.

- For use as a one-way speaking valve
- Easy to use and maintain
- Low resistance to inspired airflow
- Exclusive cough-release feature

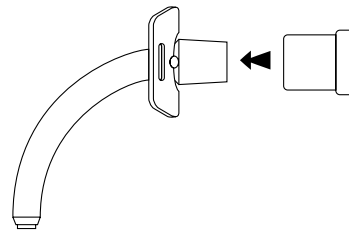

REF	Description
221201	Montgomery® Speaking Valve, Single Pack
221202	Montgomery® Speaking Valve, Double Pack

Supplied non-sterile. For single patient use.
1 speaking valve per carton (221201)
2 speaking valves per carton (221202)

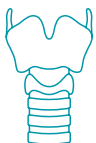



Montgomery®

Cannula Speaking Valves

Designed to allow cannula patients to vocalize without the need for finger occlusion.

All valves provide one-way airflow using a thin silicone hinged diaphragm that opens on inspiration and closes on expiration.

All valves feature our unique cough-release feature, eliminating valve or tube displacement following a forceful cough or excessive airway pressure.

- Easy-to-use and durable
- Low resistance to inspired airflow
- Exclusive cough-release feature
- 4 models to choose from

SIZE	REF
	Silicone Valve
4	350401
6	350601
8	350801
10	351001

Supplied non-sterile. For single patient use. 1 speaking valve, 1 storage container per carton.



Montgomery®

Thyroplasty Implant System



Complete standardized system for treatment of unilateral vocal fold paralysis, consisting of

- specially designed surgical instruments
- devices for measuring medialization distance prior to implant insertion
- a range of six implant sizes for female patients and six sizes for males.

Video available

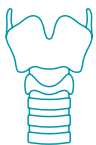



-
- Complete standardized system
 - Eliminates need to hand-fashion implants
 - Self-retaining implant design
 - No suturing is necessary
 - Reduced trauma and surgery time
 - Reversible
 - Proven clinical success
-

The Montgomery® Thyroplasty Implant System is the result of over a decade of research and development. Designed to treat unilateral vocal cord paralysis, this revolutionary system is standardized, eliminating the time-consuming process of customizing implants at the time of surgery.

Standardization translates to consistent results. Solid clinical experience involving thousands of patients has produced outstanding voice improvement while reducing long procedures and complications associated with hand-carved implants and injection techniques.



Montgomery® Thyroplasty Implant

The unique design of the Montgomery® Thyroplasty Implant consists of two major components: the rectangular base and the triangular top.



The triangular portion is made of soft silicone to medialize the vocal cord and the vocal process of the arytenoid. The hypotenuse of the triangle corresponds to the long axis of the vocal cord.

The height of the triangle is measured in millimeters and defines the implant size: 6, 7, 8, 9, 10 and 11 mm for females and 8, 9, 10, 11, 12 and 13 mm for males.

The base is made of firm silicone and features three tiers. The lateral, or outer tier, remains on the outer surface of the thyroid lamina and prevents medial displacement of the implant. The middle tier stabilizes the implant and prevents rotation. The inner tier rests against the inner surface of the thyroid lamina and prevents outward displacement. There is a common base for female and a common base for male sizes..

The base of each implant is marked with size and gender.

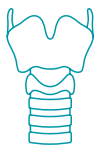

Montgomery® Thyroplasty Measuring Devices

Special measuring devices for female (green) and male (blue) patients accurately simulate vocal cord medialization eliminating the need to insert and replace multiple implants.

This results in less trauma to the patient and reduced surgery time. The disposable set includes five sizes to correspond to the five smallest implant sizes, and is available in both female and male kits.

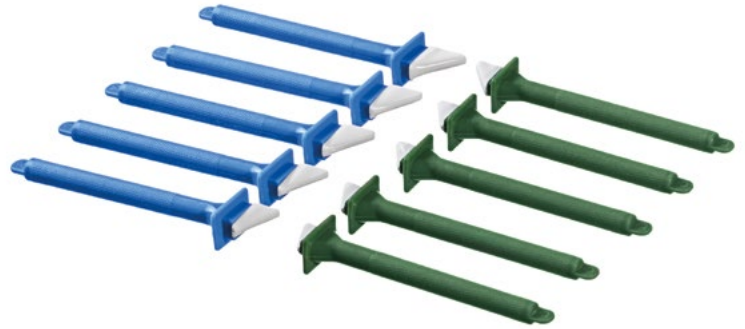

Each measuring device is marked with size and gender.



Montgomery® Thyroplasty Surgical Instruments

Custom surgical instruments facilitate locating, designing, and creating the window and inserting the implant. Available individually, or as a complete 13-piece set with sterilization tray.

The Surgical Procedure

The surgical procedure has been fine-tuned and involves a step-by-step process for locating the thyroplasty window, creating the window, determining implant size, and inserting the implant. The procedure reduces surgery time and is completely reversible. Please refer to the Instructions for Use for a step-by-step guide.

In the U.S. Boston Medical Products now makes it even easier to use the Montgomery® Thyroplasty Implant System!

A Single Procedure Kit is available and includes everything you need to perform one thyroplasty procedure. We will send you a complete instrument set, measuring kit, and six implants. After performing the case, simply send back the instruments and unused implants in the convenient supplied container.



Montgomery® Thyroplasty Implants

REF		REF	
MTF-06	Female Size 6	MTM-08	Male Size 8
MTF-07	Female Size 7	MTM-09	Male Size 9
MTF-08	Female Size 8	MTM-10	Male Size 10
MTF-09	Female Size 9	MTM-11	Male Size 11
MTF-10	Female Size 10	MTM-12	Male Size 12
MTF-11	Female Size 11	MTM-13	Male Size 13

Supplied sterile. One implant per carton.



16-Implant Sets contains 16 implants

Significant savings over purchasing individual implants

REF	
MTC-01	<i>Male and Female Combination Implant Set, contains 16 implants:</i> 1 ea. female sizes 6, 7, 8, 11 / 2 ea. female sizes 9, 10 1 ea. male sizes 8, 9, 10, 13 / 2 ea. male sizes 11, 12
MTF-01	<i>Female Implant Set, contains 16 implants:</i> 2 ea. female sizes 6, 11 / 3 ea. female sizes 7, 8, 9, 10
MTM-01	<i>Male Implant Set, contains 16 implants:</i> 2 ea. male sizes 8, 13 / 3 ea. male sizes 9, 10, 11, 12



Montgomery® Thyroplasty Measuring Device Kits

REF	
MT-300	Female Measuring Device Kit
MT-400	Male Measuring Device Kit

Supplied sterile, disposable. Kits include one of each size measuring device (5 sizes per kit).

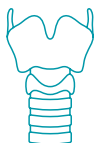
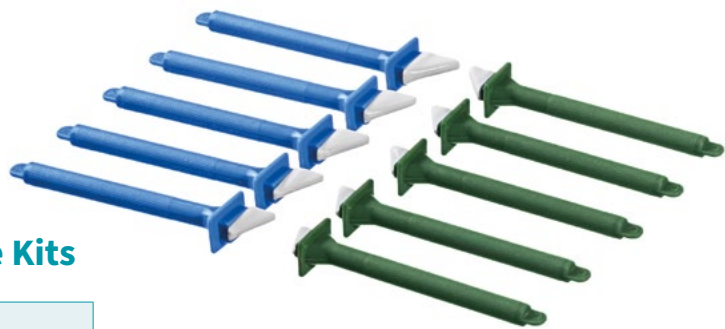

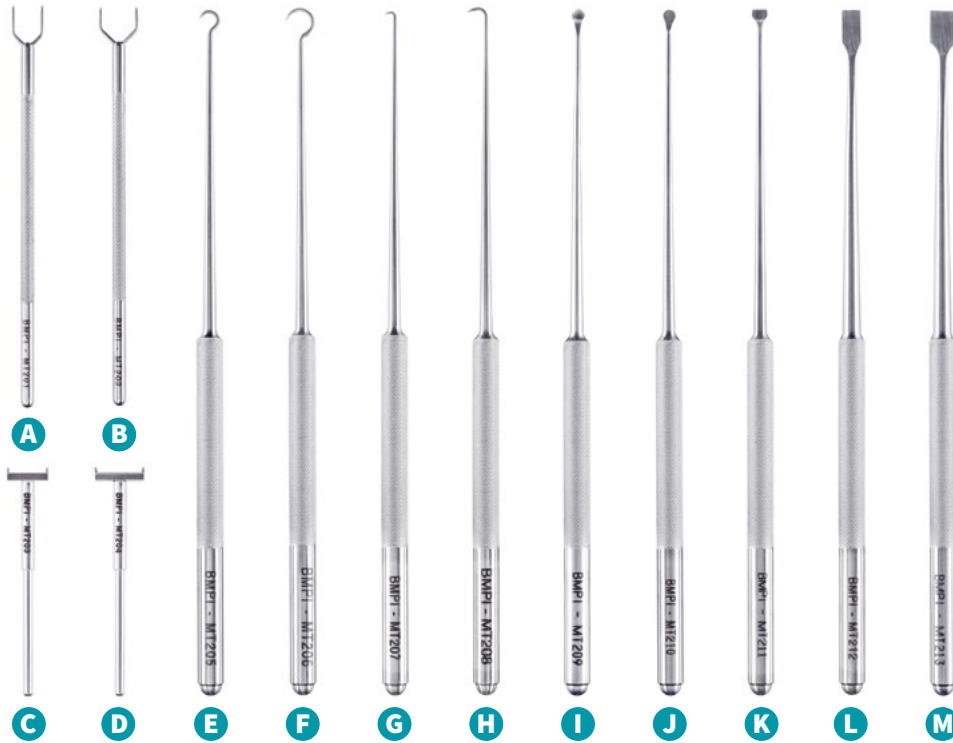

Montgomery®
Thyroplasty Surgical Instruments

REF	Description
A MT-201	7mm Female Window Caliper
B MT-202	9mm Male Window Caliper
C MT-203	Female Window Outline Instrument
D MT-204	Male Window Outline Instrument
E MT-205	Small Curved Hook
F MT-206	Large Curved Hook
G MT-207	Small Sharp Hook

REF	Description
H MT-208	Large Sharp Hook
I MT-209	3mm Duckbill Elevator
J MT-210	5mm Duckbill Elevator
K MT-211	Chisel Elevator
L MT-212	Female Implant Inserter
M MT-213	Male Implant Inserter

Supplied non-sterile. One item per carton.

A complete 13-piece Instrument Set is available which includes a custom sterilization tray

Individual instruments may also be purchased separately.

REF	Description
MT-200	13-piece Surgical Instruments Set with Custom Sterilization Tray
Supplied non-sterile.	





Multiple Procedure Thyroplasty Kit

Designed for surgeons or facilities performing multiple thyroplasty procedures annually.

REF	Thyroplasty Multiple Procedure Kit, includes:
MT-MP	<ul style="list-style-type: none"> • 1 ea. MT-200 13-piece Surgical Instrument Set with Custom Sterilization Tray • 4 ea. MT-300 Female Measuring Device Kits • 4 ea. MT-400 Male Measuring Device Kits • 1 ea. MTC-01 Male and Female Combination Implant Set (16 implants)

Single Procedure Thyroplasty Kit

A cost-effective and convenient option designed for surgeons who perform a limited number of thyroplasty procedures. Choose either a female or male kit. Boston Medical Products will send you the complete 13-piece instrument set in sterilization tray, one disposable measuring device kit, and six thyroplasty implants.

Following the surgery, simply return the instrument set and five unused implants.

REF	
MT-SPF	Female Single Procedure Kit
MT-SPM	Male Single Procedure Kit

choose



or

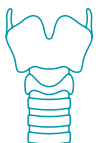

Products for Otology and Rhinology



OTOSILK™

Otological Strips

For temporary tamponade of the tympanic membrane and/or the auditory canal following otological procedures such as tympanoplasty or stapes surgery.



REF	Dimensions (mm)		
	Thickness	Length	Width
OT-17510	0.08	45	6.50
OT-16610			4.00

Supplied sterile. 200 Strips per carton (10 Strips per pouch, 20 pouches per carton).

- Convenient, economical pre-cut strips
- Non-adherent material
- Blue color for increased visualization
- Heat-sealed edges to prevent unraveling or shedding

OTOSILK™

Graft Dressing

For use as a carrier for split thickness skin grafts used in procedures such as tympanoplasty, canalplasty, mastoid tympanoplasty, correction of congenital aural atresia, and removal of canal exostoses.

The graft is placed on the dressing and trimmed to the desired size and shape. The dressing and graft combination is then placed in the external auditory canal. Following the healing process, the graft dressing is removed, leaving the newly healed graft in position.



- 10 × 15 cm sheet, easily trimmed
- Non-adherent material
- Blue color for increased visualization

REF	Dimensions (cm)		
	Thickness	Length	Width
OT-4601	0.008	15	10

Supplied sterile. 10 Dressings per carton (1 Dressing per pouch, 10 pouches per carton).





- Anatomical design for better fit and increased comfort.
- Comfortable, adjustable strap
- Small openings provide ventilation.

Doyle Ear Dressing

REF	Description
50-401N	Adult, Natural
50-401B	Adult, Blue
50-402N	Pediatric, Natural
50-402B	Pediatric, Blue
50-402G	Pediatric, Green
50-402R	Pediatric, Orange
50-402P	Pediatric, Pink
50-402A	Pediatric, Assorted Pack (2 ea. Blue, 2 ea. Pink, 1 ea. Green, 1 ea. Orange)
Supplied sterile. 6 Dressings per carton (1 Dressing per pouch, 6 pouches per carton).	

The Doyle Ear Dressing is a postoperative ear dressing used to protect the external ear following surgery.

- For both adult and pediatric patients
- Various colors for adult and pediatric patients
- Pediatric assorted pack available

Each Doyle Ear Dressing contains an ear cup with integral foam pad, adjustable strap, anatomically shaped non-adherent dressing, gauze fluff, adhesive pads, and cotton balls. Pediatric dressings include fun stickers that can be applied to the ear cup for decoration.



Septal Splints

Various designs providing septal support and reducing or preventing adhesions between the septum and lateral nasal wall following septoplasty or septorhinoplasty.

Doyle Open-Lumen Splint

- Addresses the problem of lumen closure due to blood and/or mucus accumulation by allowing inspiration and ciliary action to keep lumen patent.

REF	Description
60-203	Doyle Open-Lumen Splint, Silicone
Supplied sterile. 10 Splints per carton (1 Splint pair per pouch, 5 pouches per carton).	



- Open-lumen design – The inferior edge of the semi-tube helps to lateralize the inferior turbinate and maintain natural airflow.
- Suture holes for stabilization



Nasal Airway Splint

REF	Description
60-201	Nasal Airway Splint, Silicone
Supplied sterile. 10 Splints per carton (1 Splint pair per pouch, 5 pouches per carton).	

- Integral airway to allow nasal breathing
- Suture holes for stabilization



Intranasal Splint INS

REF	Description	Type
60-204	Intranasal Splint INS, Silicone	Soft
60-204L	Intranasal Splint INS, Silicone	Extra-Soft
Supplied sterile. 10 Splints per carton (1 Splint pair per pouch, 5 pouches per carton).		



Suture holes for stabilization



- Lengthwise slit to facilitate insertion and removal
- Suture holes for stabilization

Bivalve Nasal Splint

- Four models available: Standard or Large, 0.25 mm or 0.50 mm thick
- Can be trimmed prior to insertion
- Clear color for maximum visualisation

REF	Description	Type	Dimensions (mm)			Splints per carton
			Thickness	Length	Width	
60-301	Bivalve Nasal Splint, PTFE	Standard	0.25	42	27	10 pairs (20 splints)
60-302		Standard	0.50	42	27	
60-303		Large	0.25	60	38	
60-304		Large	0.50	60	38	
60-301S	Bivalve Nasal Splint, PTFE, single	Standard	0.25	42	27	10 splints
60-302S		Standard	0.50	42	27	
60-303S		Large	0.25	60	38	
60-304S		Large	0.50	60	38	

Custom Nasal Splint

- Medical-grade silicone or fluoroplastic
- Can be trimmed prior to insertion

REF	Dimensions (mm)	Material	Thickness (mm)
60-310	51 × 76	Fluoroplastic	0.25
60-311		Fluoroplastic	0.50
60-312		Silicone	0.13
60-313		Silicone	0.50
60-314		Silicone	1.00
60-315		Silicone	1.50

Supplied sterile. 10 Splints per carton
(1 Splint per pouch, 10 pouches per carton).



Nasal Septal Button

- Designed for non-surgical closure of septal perforations.
- Made of soft silicone
- Can be trimmed at the time of placement

Studies have shown that use of a nasal septal button increases nasal respiration while decreasing symptoms of nasal perforations which include epistaxis and crusting.

REF	Description
60-101	Nasal Septal Button Ø 3.2 cm
Supplied sterile. One item per carton.	



Two 3.20 cm diameter flanges connected by a central 7 mm diameter post.

Salman FES Stent

To help prevent post-operative adhesions and narrowing or closure of the middle meatal antrostomy following functional endoscopic sinus (FES) surgery

REF	Description
SS2000	Salman FES Stent
Supplied sterile. One item per carton.	

Two “fingers” arising from the base are introduced into the maxillary sinus through the middle meatal antrostomy. These “fingers” are designed to prevent dislodgment of the stent, eliminating the need for suturing.



Oval-shaped base that may be trimmed for different anatomies, designed to fit between the middle turbinate and lateral nasal wall.



Epi-Max™

Epistaxis Catheter

Two-balloon epistaxis catheter designed to control intranasal bleeding.



As a nasal packing, it can be used following septoplasty, rhinoplasty, and other intra-nasal surgical procedures.

Dual balloon design allows for control of anterior and/or posterior nasal bleeding.

A syringe is used to expand the balloons with normal saline. The volume of saline injected determines the ultimate size and pressure of the balloons. The result is a controlled, uniform pressure to manage bleeding.

Two lengths are available: 97 mm and 120 mm.

REF	Total Length (mm)	Usable Length (mm)
60-402	97	85
60-402L	120	95

Supplied sterile. One item per carton.

- Medical-grade silicone with blue tint for visualization
- Dual balloons with adjustable size and pressure
- Integral airway
- The integral airway tube provides a passage for breathing while the balloons are inflated.

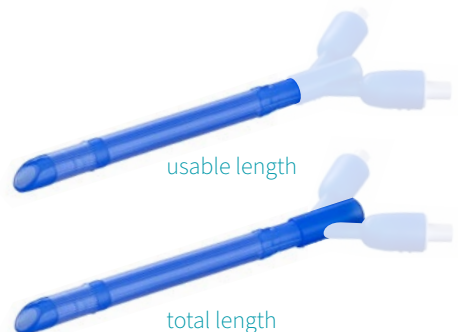

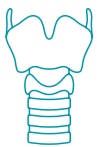

To Place an Order

Our Customer Service Representatives are available from 8:30 a.m. to 5:00 p.m. (EST) Monday through Friday. Orders can also be placed through our 24-hour fax line or by e-mail.

- Customer Service: 800-433-2674 (toll-free in the U.S.)
- Main Telephone: 508-898-9300
- 24-hour-Fax: 508-898-2373
- customerservice@bosmed.com

Prescription Policy

U.S. federal law restricts these products to sale by or on the order of a physician.

Shipment

Standard shipping within the U.S. is FedEx Ground delivery. Express orders are accepted until 4:00 p.m. (EST) for next business day delivery nationwide.

Return Policy

All sales final, no returns or exchanges will be accepted.

Warranty

Boston Medical Products, Inc. warrants that reasonable care has been used in the manufacturing of all products. All products are warranted to be free of defects at the time of shipment. For specific product warranties, please refer to individual product Instructions for Use.



Boston Medical Products, Inc. — Shrewsbury, MA, USA



Please note that only the current instructions for use apply. Details in this catalog about the use of products serve as a guide only and reflect the information available at the time of print. If necessary, please request a current version!



The instructions for use for some of our products are available only in electronic form (in pdf format) on our website.

Please see the product label for the required access information.

Please note that product availability may vary by country. Please contact us for details.



Ear, Nose & Throat

Surgical Products

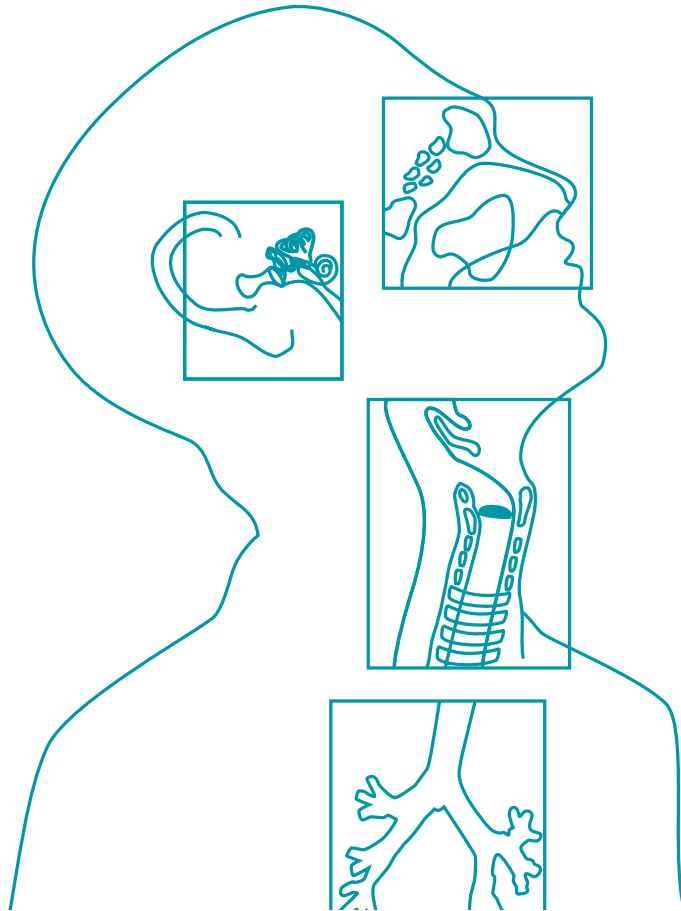

BMP-MR-PCA-ENT_EN Rev.:4



a bess group company

Boston Medical Products, Inc.

70 Chestnut Street

Shrewsbury, MA 01545 USA

Tel.: +1 (508) 898-9300

Fax: +1 (508) 898-2373

www.bosmed.com • info@bosmed.com